



Typ		P50K06	P50N06	P50R06	P50T06	P50U06	P52U06
Jmenovitý proud I_n		do 50 A	do 125 A	do 160 A	do 400 A	do 630 A	do 630 A
Jmenovité napětí U_n	AC	690 V	690 V	500 V, 690 V	690 V	690 V	690 V
	DC	440 V	240 V, 440 V	440 V	440 V	440 V	440 V
Velikost pojistkové vložky / připojovací rozteč		- / 75 mm	- / 80 mm	000 / 80 mm	00 / 80 mm	1 / 80 mm	1 / 110 mm
Charakteristika pojistkové vložky		gR	gR, aR	gR, aR	gR, aR	aR	aR

Použití

Pojistkové držáky		SP40K06	SP40T06	SP41T06	SP50U06
-------------------	---	---------	---------	---------	---------

Příslušenství

Signalizace stavu pojistkové vložky		-	VL50	VL50	VL50, VL41F + S-P50U06	
Paralelní řazení pojistkových vložek		CS-P50TUV-2PS..				





Typ	P40U10	P50U10	P50V10	P50V16	P50V30
Jmenovitý proud I_n	do 400 A	do 630 A	700 A	do 630 A	315 A
Jmenovité napětí U_n	AC DC	1 000 V 600 V	1 000 V 600 V	1 500 V 1 000 V, 1 100 V	– 3 000 V
Velikost pojistkové vložky / připojovací rozteč	1 / 110 mm	1 / 110 mm	2 / 110 mm	2 / 170 mm	2 / 330 mm
Charakteristika pojistkové vložky	gR, aR	aR	aR	gR, aR	aR

F

Použití

Pojistkové držáky		SP50U10	SP50V10	SP50X16	–
-------------------	---	---------	---------	---------	---

Příslušenství

Signalizace stavu pojistkové vložky		VL41F + S42 + 5865..	VL41F + S43 + 5865..	–
Paralelní řazení pojistkových vložek		CS-P50TUV-2PS..	–	–

POJISTKOVÉ VLOŽKY SE ŠROUBOVÝMI SPOJI P40, P50

- Jsou určeny pro jištění polovodičových zařízení.
- Mimořádně nízké hodnoty I^2t_c a omezených proudů.
- Malé rozměry a nízké ztráty.
- Pojistkové vložky neobsahují škodlivé látky dle nařízení RoHS (kadmium, olovo a ostatní).
- Použití v pojistkových držácích SP40..., SP41... a SP50 viz str. G15
- Charakteristika gR pro jištění polovodičových prvků před přetížením a zkratem.
- Charakteristika aR pro jištění polovodičových prvků pouze před zkratem.
- Pojistková vložka s označením P40U10S, P50U10S, P50V10S, P50V16S je vybavena signalizací.
- Možnost paralelního řazení pojistek, viz str. G18.



P50K06 50A gR



P50N06 125A aR



P50R06 160A aR

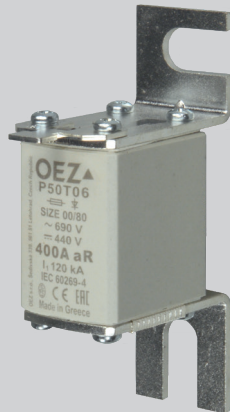

P50T06 400A aR

Pojistkové vložky P50K06 do AC 690 V / DC 440 V

I_n [A]	Typ	Objednáací kód	Ztráty [W]	Oteplení [K]	I^2t_c [A ² s]	I^2t_c [A ² s]	Hmotnost [kg]	Balení [ks]
10	P50K06 10A gR	OEZ:06593	4,30	33	1	17	0,060	3
16	P50K06 16A gR	OEZ:06594	4,40	31	3	52	0,060	3
20	P50K06 20A gR	OEZ:06595	6,50	35	5	90	0,060	3
25	P50K06 25A gR	OEZ:06596	8,50	43	8	160	0,060	3
32	P50K06 32A gR	OEZ:06597	8,90	49	21	400	0,060	3
40	P50K06 40A gR	OEZ:06598	11,00	52	33	600	0,060	3
50	P50K06 50A gR	OEZ:06599	13,80	53	65	1 250	0,060	3

Pojistkové vložky P50N06 do AC 690 V / DC 440 V

I_n [A]	Typ	Objednáací kód	Ztráty [W]	Oteplení [K]	I^2t_c [A ² s]	I^2t_c [A ² s]	Hmotnost [kg]	Balení [ks]
25	P50N06 25A gR	OEZ:06608	9,50	40	8	120	0,140	3
32	P50N06 32A gR	OEZ:06609	12,30	54	15	190	0,140	3
40	P50N06 40A gR	OEZ:06610	14,80	64	21	400	0,140	3
50	P50N06 50A gR	OEZ:06611	17,50	66	48	950	0,140	3
63	P50N06 63A gR	OEZ:06612	18,80	68	108	2 050	0,140	3
80	P50N06 80A aR	OEZ:06613	22,50	62	205	3 500	0,140	3
100	P50N06 100A aR	OEZ:06614	31,50	70	340	5 400	0,140	3
125	P50N06 125A aR ¹⁾	OEZ:06615	39,00	88	645	11 800	0,140	3

Pojistkové vložky P50R06 do AC 690 V / DC 440 V

I_n [A]	Typ	Objednáací kód	Ztráty [W]	Oteplení [K]	I^2t_c [A ² s]	I^2t_c [A ² s]	Hmotnost [kg]	Balení [ks]
16	P50R06 16A gR	OEZ:06618	6,70	35	9	73	0,140	3
20	P50R06 20A gR	OEZ:06619	7,80	33	15	90	0,140	3
25	P50R06 25A gR	OEZ:06620	7,50	33	22	250	0,140	3
32	P50R06 32A gR	OEZ:06621	11,00	42	38	350	0,140	3
40	P50R06 40A gR	OEZ:06622	12,00	42	50	480	0,140	3
50	P50R06 50A gR	OEZ:06623	14,50	45	70	1 050	0,140	3
63	P50R06 63A gR	OEZ:06624	23,00	74	100	1 960	0,140	3
80	P50R06 80A aR	OEZ:06625	20,00	52	450	2 200	0,140	3
100	P50R06 100A aR	OEZ:06626	26,00	56	820	3 650	0,140	3
125	P50R06 125A aR	OEZ:06627	30,00	56	1 700	7 800	0,140	3
160	P50R06 160A aR ²⁾	OEZ:06628	37,20	72	3 300	14 000	0,140	3

Pojistkové vložky P50T06 do AC 690 V / DC 440 V

I_n [A]	Typ	Objednáací kód	Ztráty [W]	Oteplení [K]	I^2t_c [A ² s]	I^2t_c [A ² s]	Hmotnost [kg]	Balení [ks]
10	P50T06 10A gR	OEZ:06646	6,70	25	4	40	0,230	3
16	P50T06 16A gR	OEZ:06647	6,80	30	9	60	0,230	3
20	P50T06 20A gR	OEZ:06648	8,00	33	15	75	0,230	3
25	P50T06 25A gR	OEZ:06649	8,20	35	30	170	0,230	3
32	P50T06 32A gR	OEZ:06650	10,80	40	42	350	0,230	3
40	P50T06 40A gR	OEZ:06651	12,50	45	50	480	0,230	3
50	P50T06 50A gR	OEZ:06652	16,00	48	62	760	0,230	3
63	P50T06 63A gR	OEZ:06653	18,50	52	98	1 800	0,230	3
80	P50T06 80A gR	OEZ:06654	23,00	55	190	3 200	0,230	3
100	P50T06 100A gR	OEZ:06655	29,00	59	400	5 200	0,230	3
125	P50T06 125A aR	OEZ:06656	28,40	59	1 500	7 600	0,230	3
160	P50T06 160A aR	OEZ:06657	35,50	70	2 950	15 000	0,230	3
200	P50T06 200A aR	OEZ:06658	45,50	75	4 300	26 000	0,230	3
250	P50T06 250A aR	OEZ:06659	50,70	78	10 400	51 000	0,230	3
315	P50T06 315A aR	OEZ:06660	53,50	78	22 000	107 000	0,230	3
350	P50T06 350A aR	OEZ:06661	58,80	79	28 000	135 000	0,230	3
400	P50T06 400A aR	OEZ:06662	74,50	85	36 000	170 000	0,230	3

¹⁾ U_n = DC 240 V

²⁾ U_n = AC 500 V



P50U06 630A aR



P52U06 630A aR



P40U10 400A aR

Pojistkové vložky P50U06 do AC 690 V / DC 440 V

I_n [A]	Typ	Objednáací kód	Ztráty [W]	Oteplení [K]	I^2t_c [A ² s]	I^2t_c [A ² s]	Hmotnost [kg]	Balení [ks]
100	P50U06 100A aR	OEZ:11875	25,00	55	540	3 200	0,390	3
125	P50U06 125A aR	OEZ:11876	28,00	57	1 000	6 000	0,390	3
160	P50U06 160A aR	OEZ:11877	35,00	68	1 800	10 500	0,390	3
200	P50U06 200A aR	OEZ:11878	42,00	69	3 000	17 500	0,390	3
250	P50U06 250A aR	OEZ:10546	53,50	77	5 000	28 500	0,390	3
315	P50U06 315A aR	OEZ:10547	61,00	82	9 200	53 500	0,390	3
350	P50U06 350A aR	OEZ:10548	69,00	92	12 100	66 000	0,390	3
400	P50U06 400A aR	OEZ:10549	70,50	85	19 000	110 000	0,390	3
450	P50U06 450A aR	OEZ:11879	71,00	80	33 000	180 000	0,390	3
500	P50U06 500A aR	OEZ:10550	84,00	90	50 000	215 000	0,390	3
550	P50U06 550A aR	OEZ:11880	87,00	90	67 000	290 000	0,390	3
630	P50U06 630A aR	OEZ:10551	96,00	93	99 000	440 000	0,390	3

Pojistkové vložky P52U06 do AC 690 V / DC 440 V

I_n [A]	Typ	Objednáací kód	Ztráty [W]	Oteplení [K]	I^2t_c [A ² s]	I^2t_c [A ² s]	Hmotnost [kg]	Balení [ks]
100	P52U06 100A aR	OEZ:14836	25,00	55	540	3 200	0,430	3
125	P52U06 125A aR	OEZ:14837	28,00	57	1 000	6 000	0,430	3
160	P52U06 160A aR	OEZ:14838	35,00	68	1 800	10 500	0,430	3
200	P52U06 200A aR	OEZ:11886	42,00	69	3 000	17 500	0,430	3
250	P52U06 250A aR	OEZ:10552	53,50	77	5 000	28 500	0,430	3
315	P52U06 315A aR	OEZ:10553	61,00	82	9 200	53 500	0,430	3
350	P52U06 350A aR	OEZ:10554	69,00	92	12 100	66 000	0,430	3
400	P52U06 400A aR	OEZ:10555	70,50	85	19 000	110 000	0,430	3
450	P52U06 450A aR	OEZ:14839	71,00	80	33 000	180 000	0,430	3
500	P52U06 500A aR	OEZ:10556	84,00	90	50 000	215 000	0,430	3
550	P52U06 550A aR	OEZ:14840	87,00	90	67 000	290 000	0,430	3
630	P52U06 630A aR	OEZ:10557	96,00	93	99 000	440 000	0,430	3

Pojistkové vložky P40U10 do AC 1 000 V / DC 600 V

I_n [A]	Typ	Objednáací kód	Ztráty [W]	Oteplení [K]	I^2t_c [A ² s]	I^2t_c [A ² s]	Hmotnost [kg]	Balení [ks]
32	P40U10 32A gR	OEZ:09013	9,00	32	45	4 500	0,550	3
40	P40U10 40A gR	OEZ:09014	13,00	35	75	6 000	0,550	3
50	P40U10 50A gR	OEZ:09015	18,00	45	110	8 000	0,550	3
63	P40U10 63A gR	OEZ:09016	25,00	62	170	9 000	0,550	3
80	P40U10 80A aR	OEZ:06548	30,00	63	390	12 000	0,550	3
100	P40U10 100A aR	OEZ:13501	39,00	72	650	15 000	0,550	3
125	P40U10 125A aR	OEZ:06551	36,00	63	1 300	25 000	0,550	3
160	P40U10 160A aR	OEZ:06553	50,00	83	2 200	33 000	0,550	3
200	P40U10 200A aR	OEZ:06555	58,50	85	4 400	55 000	0,550	3
250	P40U10 250A aR	OEZ:06557	68,00	91	8 500	105 000	0,550	3
315	P40U10 315A aR	OEZ:06559	76,50	94	13 600	210 000	0,550	3
350	P40U10 350A aR	OEZ:11245	82,00	96	17 500	250 000	0,550	3
400	P40U10 400A aR	OEZ:06561	99,50	105	24 200	280 000	0,550	3
32	P40U10S 32A gR	OEZ:11835	9,00	32	45	4 500	0,550	3
40	P40U10S 40A gR	OEZ:11834	13,00	35	75	6 000	0,550	3
50	P40U10S 50A gR	OEZ:11833	18,00	45	110	8 000	0,550	3
63	P40U10S 63A gR	OEZ:11832	25,00	62	170	9 000	0,550	3
80	P40U10S 80A aR	OEZ:06549	30,00	63	390	12 000	0,550	3
100	P40U10S 100A aR	OEZ:06550	39,00	72	650	15 000	0,550	3
125	P40U10S 125A aR	OEZ:06552	36,00	63	1 300	25 000	0,550	3
160	P40U10S 160A aR	OEZ:06554	50,00	83	2 200	33 000	0,550	3
200	P40U10S 200A aR	OEZ:06556	58,50	85	4 400	55 000	0,550	3
250	P40U10S 250A aR	OEZ:06558	68,00	91	8 500	105 000	0,550	3
315	P40U10S 315A aR	OEZ:06560	76,50	94	13 600	210 000	0,550	3
350	P40U10S 350A aR	OEZ:13749	82,00	96	17 500	250 000	0,550	3
400	P40U10S 400A aR	OEZ:06562	99,50	105	24 200	280 000	0,550	3

P40U10S.. provedení se signalizací stavu pojistkové vložky

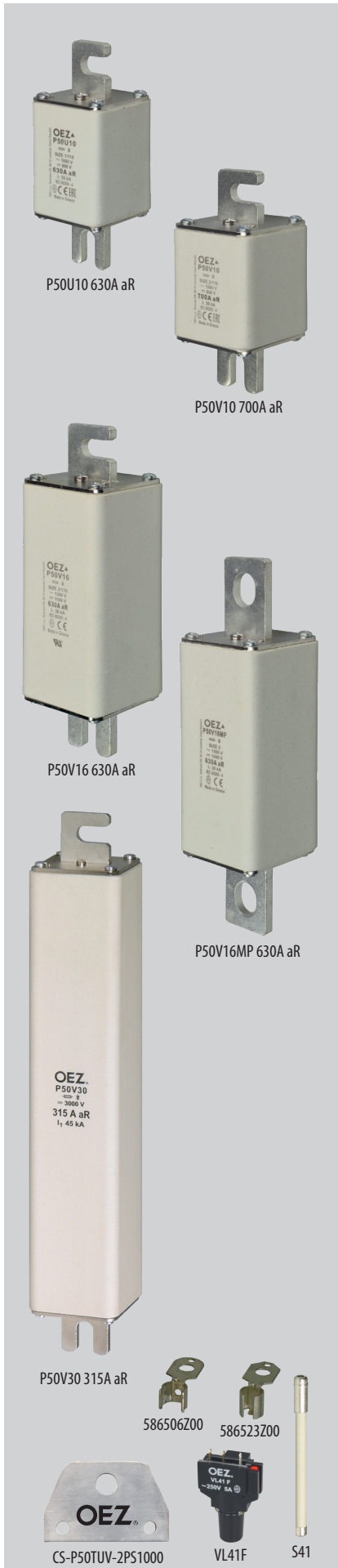

F

Pojistkové vložky P50U10.. do AC 1 000 V / DC 600 V

I_n [A]	Typ	Objednací kód	Ztráty [W]	Oteplení [K]	I^2t_c [A ² s]	I^2t_c [A ² s]	Hmotnost [kg]	Balení [ks]
400	P50U10 400A aR	OEZ:08677	80,00	90	25 000	260 000	0,550	3
450	P50U10 450A aR	OEZ:08657	90,00	94	36 200	380 000	0,550	3
500	P50U10 500A aR	OEZ:08654	105,00	100	46 000	500 000	0,550	3
550	P50U10 550A aR	OEZ:08655	110,00	107	68 000	700 000	0,550	3
630	P50U10 630A aR	OEZ:08656	127,00	110	90 000	850 000	0,550	3
400	P50U10S 400A aR	OEZ:20519	80,00	90	25 000	260 000	0,550	3
450	P50U10S 450A aR	OEZ:08680	90,00	94	36 200	380 000	0,550	3
500	P50U10S 500A aR	OEZ:08681	105,00	100	46 000	500 000	0,550	3
550	P50U10S 550A aR	OEZ:17515	110,00	107	68 000	700 000	0,550	3
630	P50U10S 630A aR	OEZ:08571	127,00	110	90 000	850 000	0,550	3

P50U10S.. provedení se signalizací stavu pojistkové vložky

Pojistkové vložky P50V10.. do AC 1 000 V / DC 600 V

I_n [A]	Typ	Objednací kód	Ztráty [W]	Oteplení [K]	I^2t_c [A ² s]	I^2t_c [A ² s]	Hmotnost [kg]	Balení [ks]
700	P50V10 700A aR	OEZ:08682	125,00	112	140 000	1 100 000	0,730	3
700	P50V10S 700A aR	OEZ:08683	125,00	112	140 000	1 100 000	0,730	3

P50V10S.. provedení se signalizací stavu pojistkové vložky

Pojistkové vložky P50V16.. do AC 1 500 V / DC 1 100 V

I_n [A]	Typ	Objednací kód	Ztráty [W]	Oteplení [K]	I^2t_c [A ² s]	AC I^2t_c [A ² s]	DC I^2t_c [A ² s]	Hmotnost [kg]	Balení [ks]
40	P50V16 40A gR	OEZ:10522	26,00	45	45	900	600	1,250	1
50	P50V16 50A gR	OEZ:15570	27,00	45	100	1 800	1 100	1,250	1
63	P50V16 63A gR	OEZ:15571	34,00	55	200	3 100	1 600	1,250	1
80	P50V16 80A aR	OEZ:15572	42,00	58	300	3 900	1 800	1,250	1
100	P50V16 100A aR	OEZ:14900	45,00	58	550	8 700	4 500	1,250	1
125	P50V16 125A aR	OEZ:10523	59,00	68	900	11 800	7 500	1,250	1
160	P50V16 160A aR	OEZ:10459	54,00	62	2 500	37 000	25 000	1,250	1
200	P50V16 200A aR	OEZ:10524	56,00	62	6 000	70 000	58 000	1,250	1
250	P50V16 250A aR	OEZ:10525	59,00	62	15 000	165 000	120 000	1,250	1
315	P50V16 315A aR	OEZ:11285	76,00	66	28 000	250 000	200 000	1,250	1
400	P50V16 400A aR¹⁾	OEZ:11866	89,00	72	58 000	470 000	280 000	1,250	1
500	P50V16 500A aR¹⁾	OEZ:11817	109,00	81	110 000	800 000	490 000	1,250	1
630	P50V16 630A aR¹⁾	OEZ:08415	163,00	88	170 000	1 100 000	750 000	1,250	1
630	P50V16MP 630A aR¹⁾	OEZ:10468	163,00	85	170 000	1 100 000	750 000	1,250	1
40	P50V16S 40A gR	OEZ:17734	26,00	45	45	900	600	1,250	1
63	P50V16S 63A gR	OEZ:34285	34,00	55	200	3 100	1 600	1,250	1
100	P50V16S 100A aR	OEZ:13744	45,00	58	550	8 700	4 500	1,250	1
125	P50V16S 125A aR	OEZ:10515	59,00	68	900	11 800	7 500	1,250	1
160	P50V16S 160A aR	OEZ:10460	54,00	62	2 500	37 000	25 000	1,250	1
200	P50V16S 200A aR	OEZ:10514	56,00	62	6 000	70 000	58 000	1,250	1
250	P50V16S 250A aR	OEZ:10477	59,00	62	15 000	165 000	120 000	1,250	1
315	P50V16S 315A aR	OEZ:13625	76,00	66	28 000	250 000	200 000	1,250	1
400	P50V16S 400A aR¹⁾	OEZ:14907	89,00	72	58 000	470 000	280 000	1,250	1
500	P50V16S 500A aR¹⁾	OEZ:13700	109,00	81	110 000	800 000	490 000	1,250	1
630	P50V16S 630A aR¹⁾	OEZ:13701	163,00	88	170 000	1 100 000	750 000	1,250	1

¹⁾ $U_n = DC 1 000 V$

P50V16S.. provedení se signalizací stavu pojistkové vložky

Pojistkové vložky P50V30.. do DC 3 000 V

I_n [A]	Typ	Objednací kód	Ztráty [W]	Oteplení [K]	I^2t_c [A ² s]	I^2t_c [A ² s]	Hmotnost [kg]	Balení [ks]
315	P50V30 315A aR	OEZ:11295	245,00	95	65 000	300 000	2,650	1

Příslušenství

Signalizace stavu pojistkových vložek	VL.., S4.., 5865.., S-P50U06	str. F30, E29
Švorky pro paralelní řazení pojistkových vložek	CS-P50TUV-2PS..	str. G18

Parametry

Typ		P50K06	P50N06	P50R06	P50T06	P50U06	P52U06
Normy		IEC 60269-1, -2, -4; ČSN EN 60269-1, -4 ČSN 354701 -2 EN 60269	IEC 60269-1, -2, -4; ČSN EN 60269-1, -4 ČSN 354701 -2 EN 60269	IEC 60269-1, -2, -4; ČSN EN 60269-1, -4 ČSN 354701 -2 EN 60269	IEC 60269-1, -2, -4; ČSN EN 60269-1, -4 ČSN 354701 -2 EN 60269	IEC 60269-1, -2, -4; ČSN EN 60269-1, -4 ČSN 354701 -2 EN 60269	IEC 60269-1, -2, -4; ČSN EN 60269-1, -4 ČSN 354701 -2 EN 60269
Certifikační značky							
Jmenovité napětí	U _n	AC 690 V DC 440 V	690 V 240 V, 440 V	500 V, 690 V 440 V	690 V 440 V	690 V 440 V	690 V 440 V
Jmenovitý proud	I _n	6 ÷ 50 A	25 ÷ 125 A	6 ÷ 160 A	10 ÷ 400 A	100 ÷ 630 A	100 ÷ 630 A
Jmenovitý kmitočet	f _n	50 Hz	50 Hz	50 Hz	50 Hz	50 Hz	50 Hz
Jmenovitá vypínací schopnost (efektivní hodnota)	I ₁	AC 120 kA DC 50 kA	120 kA 50 kA	120 kA 50 kA	120 kA 50 kA	120 kA 50 kA	120 kA 50 kA
Charakteristika		gR	gR	gR, aR	gR, aR	aR	aR
Velikost / přípojovací rozteč		- / 75 mm	- / 80 mm	000 / 80 mm	00 / 80 mm	1 / 80 mm	1 / 110 mm
Signalizace		-	-	VL50	VL50	VL50, S-P50U06 + VL41F	VL50, S-P50U06 + VL41F

Typ		P40U10	P50U10	P50V10	P50V16	P50V16MP	P50V30
Normy		IEC 60269-1, -4; ČSN EN 60269-1, -4 EN 60269	IEC 60269-1, -2, -4; ČSN EN 60269-1, -4 EN 60269	IEC 60269-1, -2, -4; ČSN EN 60269-1, -4 EN 60269	IEC 60269-1, -2, -4; ČSN EN 60269-1, -4 EN 60269	IEC 60269-1, -6; ČSN EN 60269-1, -6	IEC 60269-1, -4; ČSN EN 60269-1, -4
Certifikační značky							
Jmenovité napětí	U _n	AC 1 000 V DC 600 V	1 000 V 600 V	1 000 V 600 V	1 500 V 1 000 V, 1 100 V	1 500 V 1 000 V	- 3 000 V
Jmenovitý proud	I _n	32 ÷ 400 A	400 ÷ 630 A	700 A	40 ÷ 630 A	630 A	315 A
Jmenovitý kmitočet	f _n	50 Hz	50 Hz	50 Hz	50 Hz	50 Hz	50 Hz
Jmenovitá vypínací schopnost (efektivní hodnota)	I ₁	AC 100 kA DC 50 kA	50 kA 45 kA	50 kA 45 kA	30 kA 47 kA	30 kA 47 kA	- 45 kA
Charakteristika		gR, aR	aR	aR	gR, aR	aR	aR
Velikost / přípojovací rozteč		1 / 110 mm	1 / 110 mm	2 / 110 mm	2 / 170 mm	1 / 190 mm	2 / 330 mm
Signalizace		VL41F + S42 + 5865..	VL41F + S42 + 5865..	VL41F + S42 + 5865..	VL41F + S43 + 5865..	VL41F + S43 + 5865..	-

Přípojovací průřez podle ČSN 354701-4, IEC 60269-4 (proudová hustota 1 ÷ 1,6 A/mm min. 500 mm z každé strany pojistkové vložky).

Rozměry

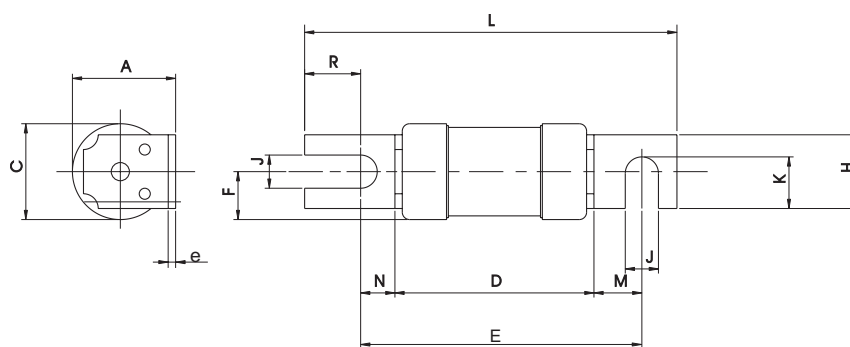

Typ	A	D	E	F	H	J	K	L	M	N	R	e	ØC
P50K06	19	52,5	71,5	9	12	6	9	88	12	7,0	14,0	1,4	18
P50N06	29	53,5	75,8	13	19	9	14	103	13	9,3	19,7	2,0	26

Rozměry
P50R06, P50T06

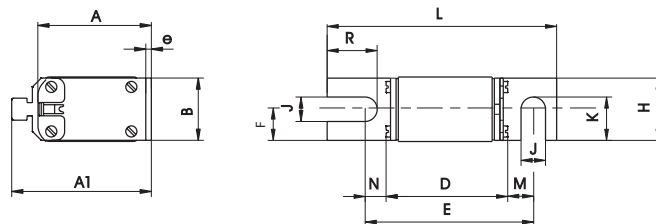

Typ	A	A1	B	D	E	F	H	J	K	L	M	N	R	e
P50R06	46	58	21	52,9	74,5	10,5	20	9	14,5	101,5	12,5	9,5	22,5	2,5
P50T06	50	63	30	52,9	75,0	15,0	28	11	19,5	102,5	13,0	9,5	22,5	2,5

P50U06, P52U06

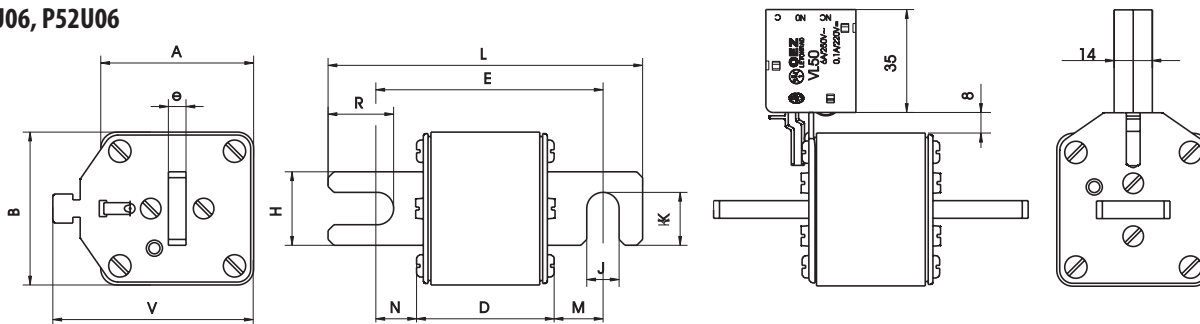

Typ	A	B	D	E	e	H	J	K	L	M	N	R	V
P50U06	52	52	47	77	6	25	11	18	107	16	13	22,3	68,5
P52U06	52	52	47	107	6	25	11	18	137	31	28	22,3	68,5

P40U10, P50U10, P50V10, P50V16

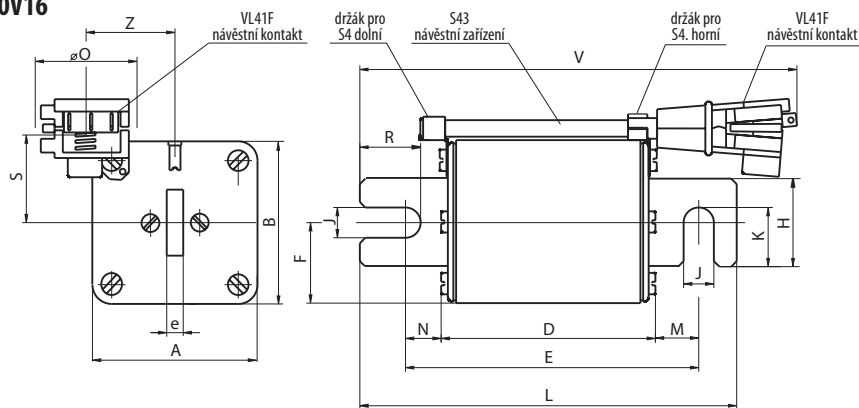

Typ	A	B	D	E	F	H	J	K	L	M	N	R	e	V	Ø0	S	Z
P40U10	52	52	78,4	106,6	26	25	11	18,0	137	15,7	12,5	22,3	6	160	36,5	30	30
P50U10	52	52	78,4	106,6	26	25	11	18,0	137	15,7	12,5	22,3	6	160	36,5	30	30
P50V10	60	60	78,4	105,6	30	32	11	21,5	137	15,1	12,1	22,1	6	160	36,5	33	33
P50V16	60	60	137,0	165,5	30	32	11	21,5	196	15,8	12,8	22,1	6	220	36,5	33	33

P50V30

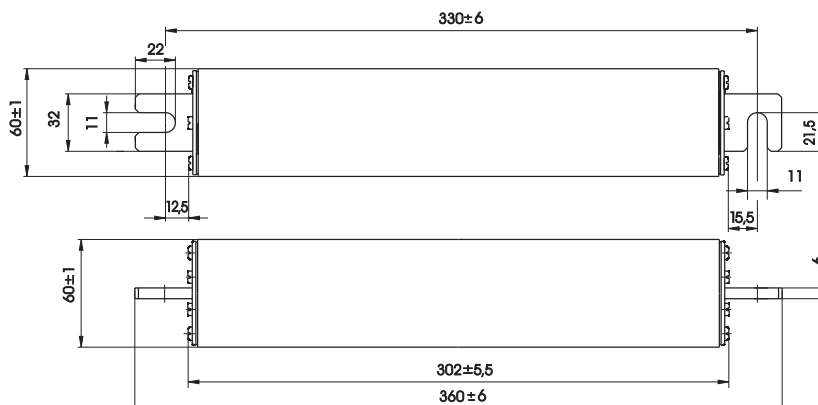

Charakteristiky

Tavná ampérekundová charakteristika
P50K06

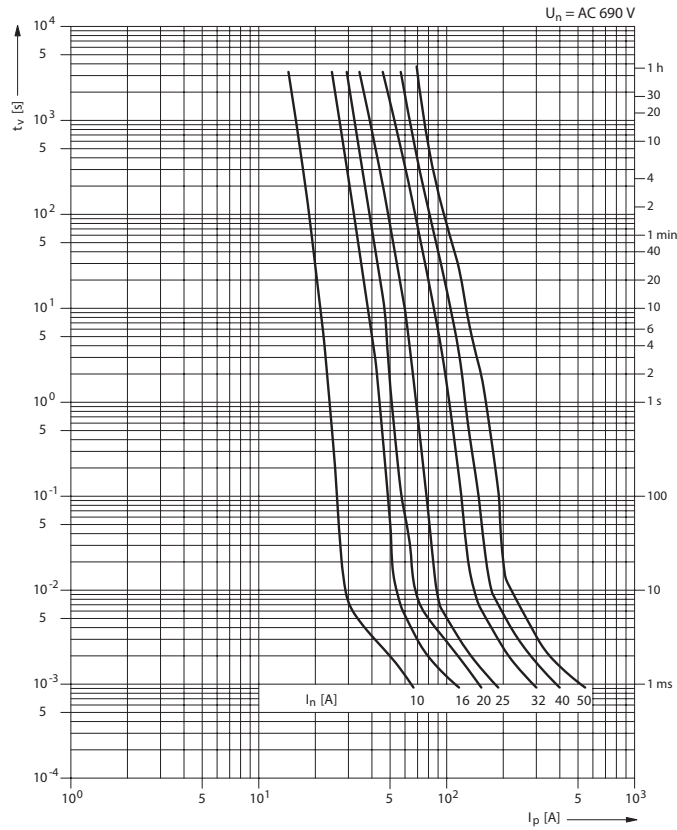

Omezovací charakteristika
P50K06

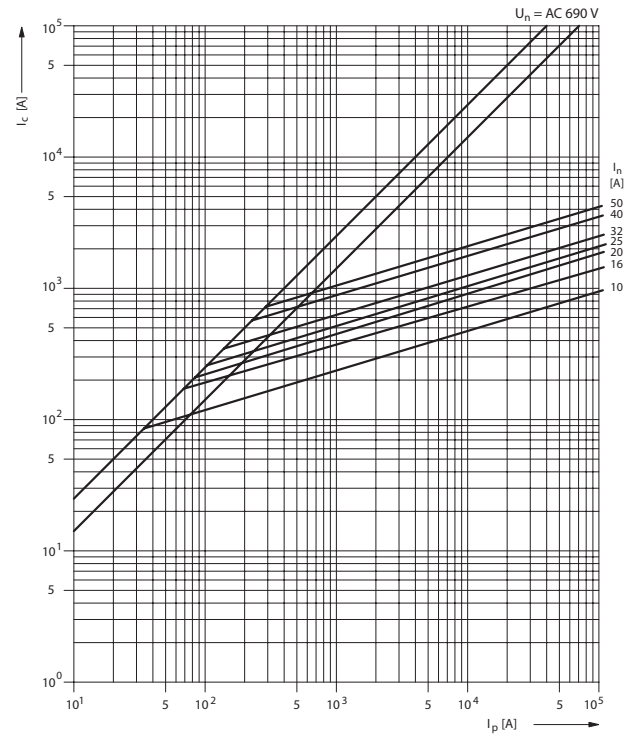

Tavná ampérekundová charakteristika
P50N06 gR, aR

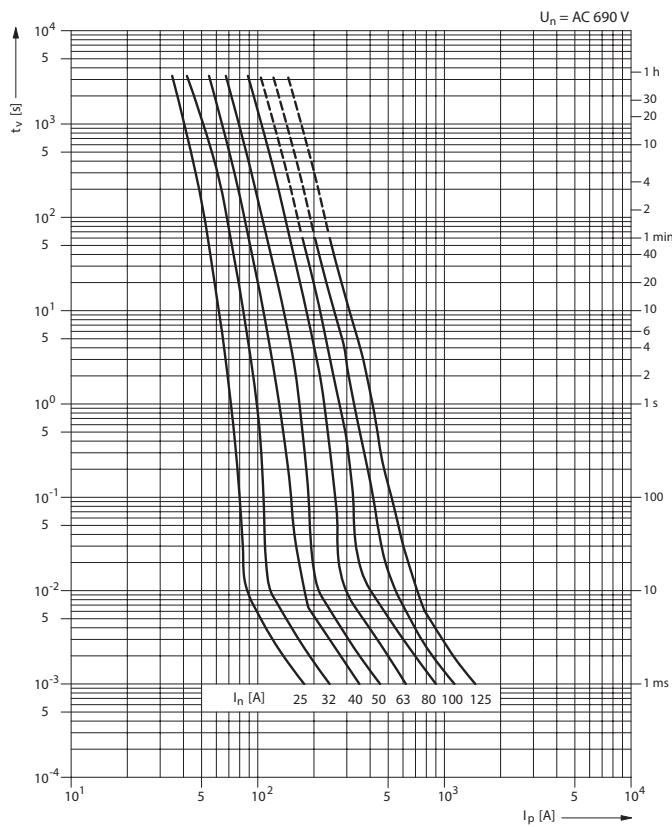

Omezovací charakteristika
P50N06 gR, aR

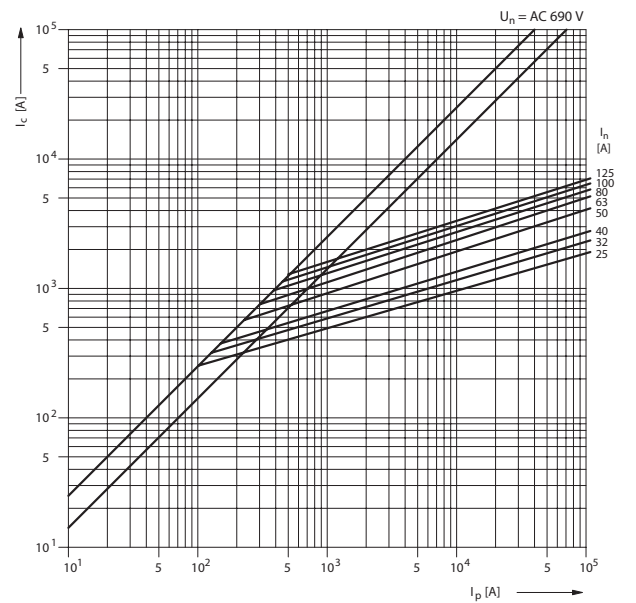

Charakteristiky

Koeficient „k“ závislosti I^2t_c na provozním napětí
 $(I^2t_c)_{f(U)} = k \times I^2t_c$
P50K06, P50N06

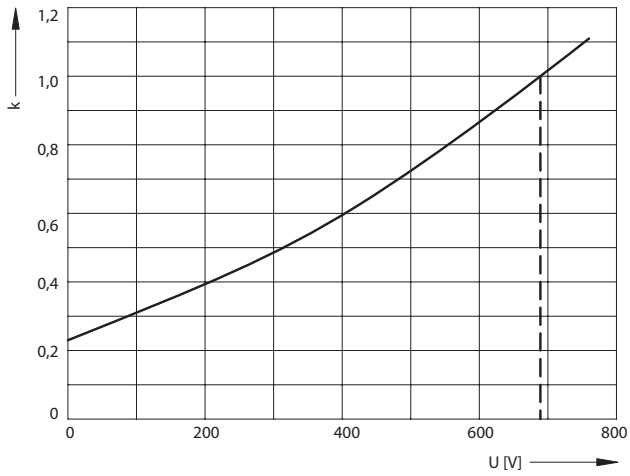

Závislost přepětí na pojistkové vložce pro různá provozní napětí
P50K06, P50N06

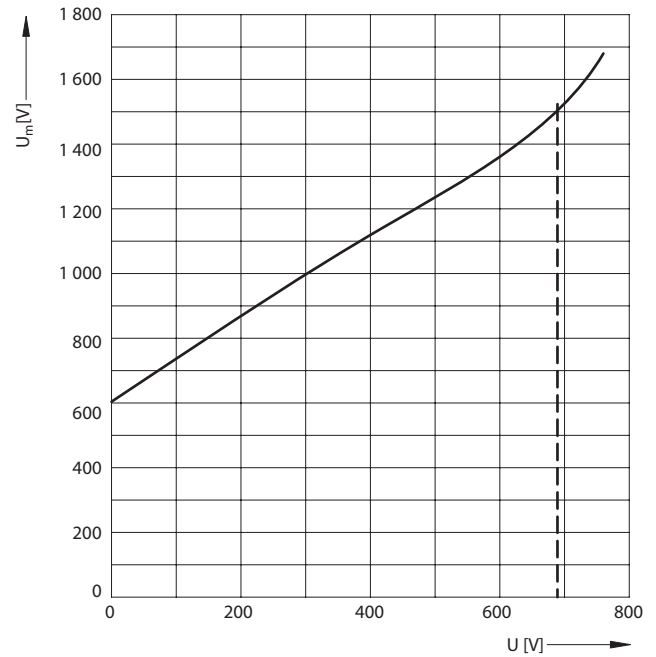

Tavná ampérsekundová charakteristika
P50R06 gR, aR

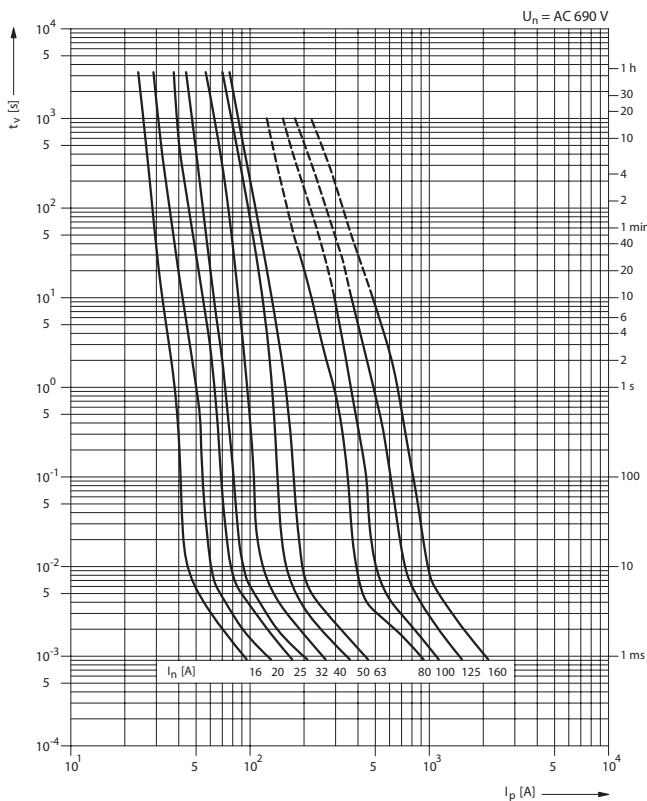

Tavná ampérsekundová charakteristika
P50T06 gR

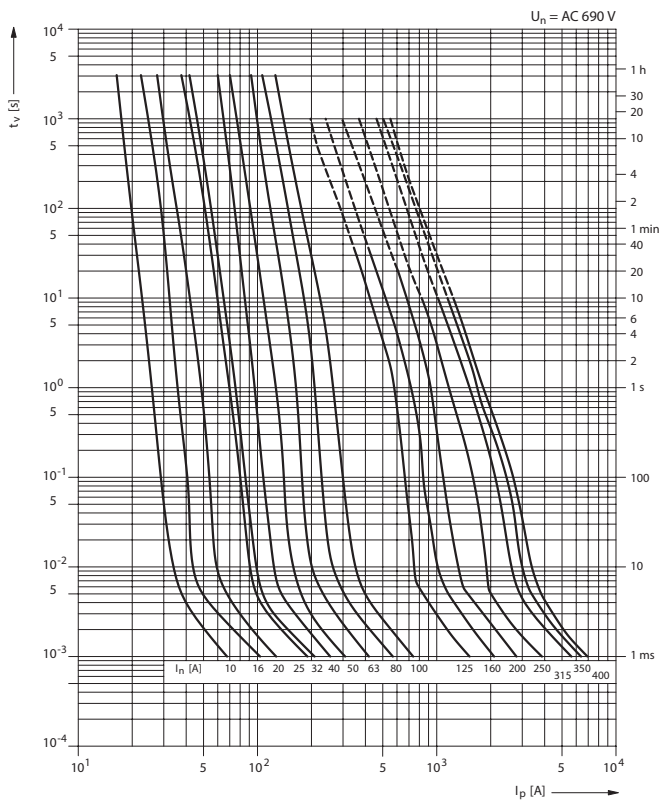

Charakteristiky

Tavná ampérsekundová charakteristika
P50U06, P52U06 aR

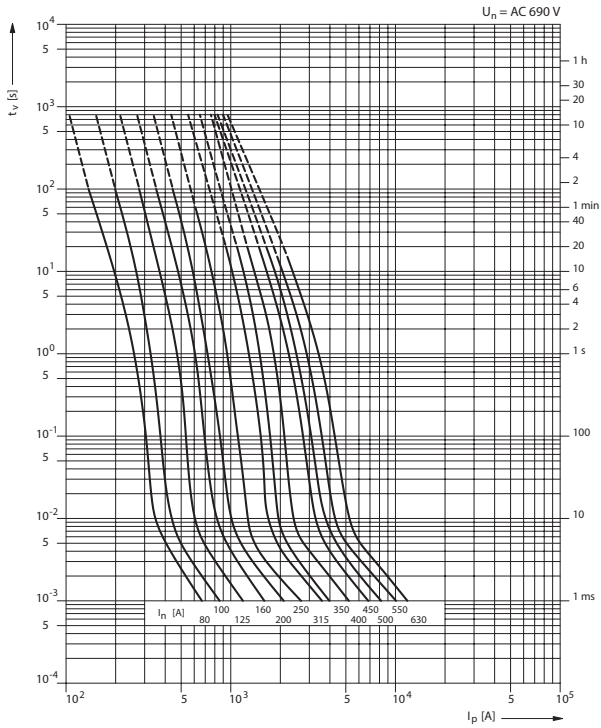

Omezovací charakteristika
P50R06 gR, aR

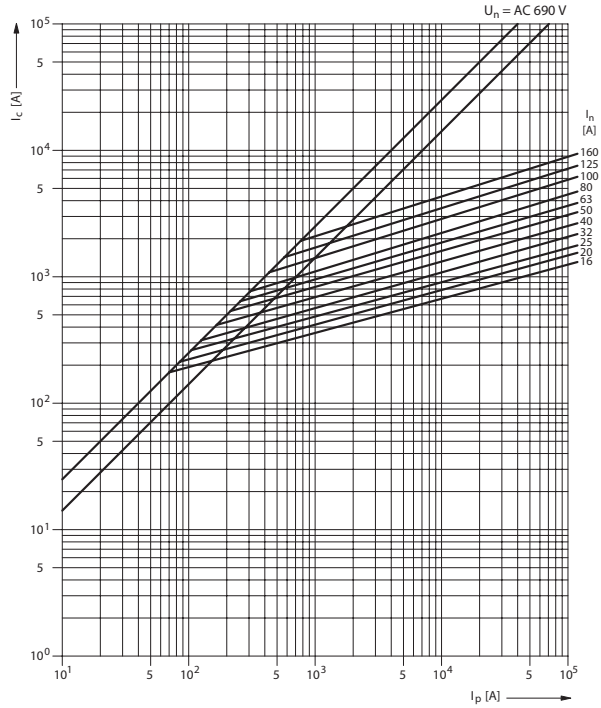

Omezovací charakteristika
P50T06 gR, aR

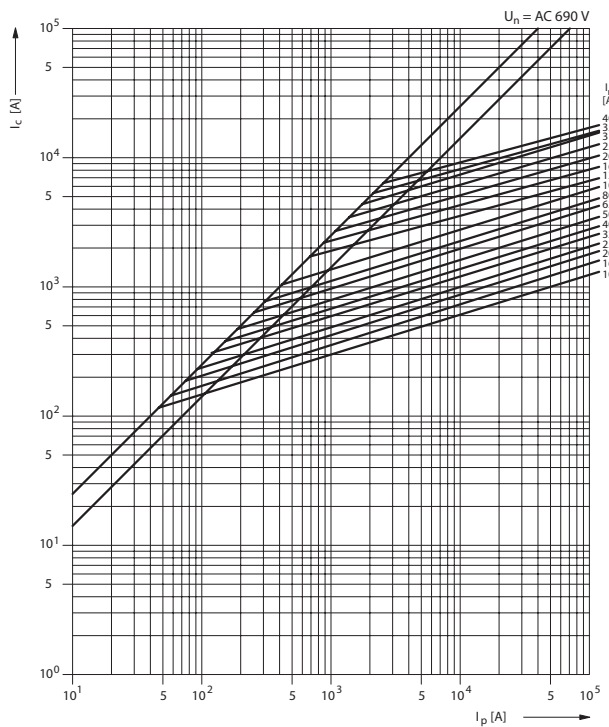

Omezovací charakteristika
P50U06, P52U06 aR

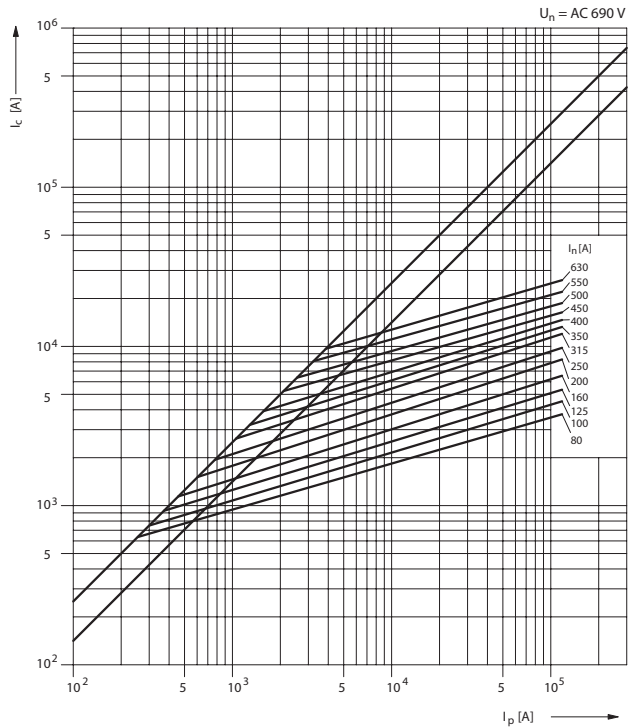

Charakteristiky

Koeficient „k“ závislosti I^2t_c na provozním napětí
 $(I^2t_c)_{f(U)} = k \times I^2t_c$

P50R06, P50T06

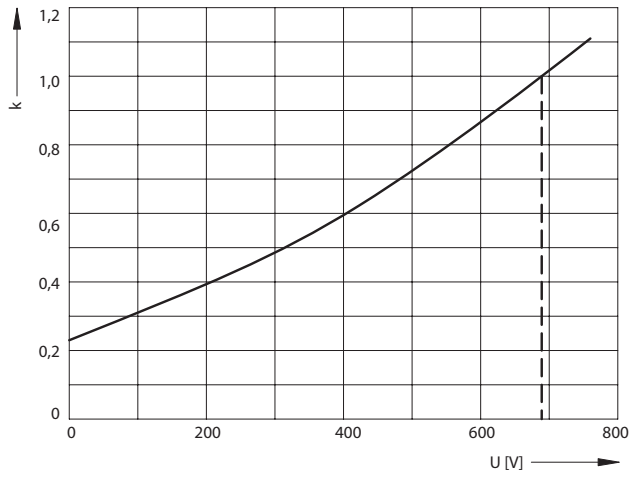

Závislost přepětí na pojistkové vložce pro různá provozní napětí
P50R06, P50T06

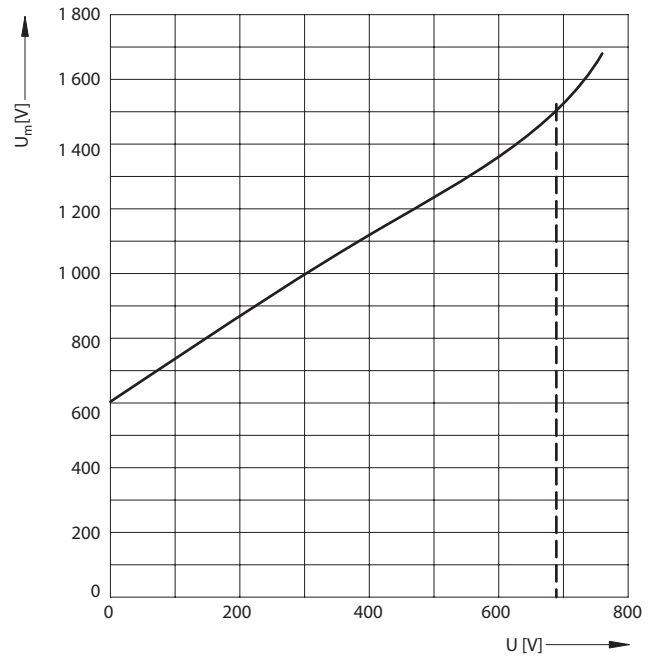

Koeficient „k“ závislosti I^2t_c na provozním napětí
 $(I^2t_c)_{f(U)} = k \times I^2t_c$

P50U06, P52U06

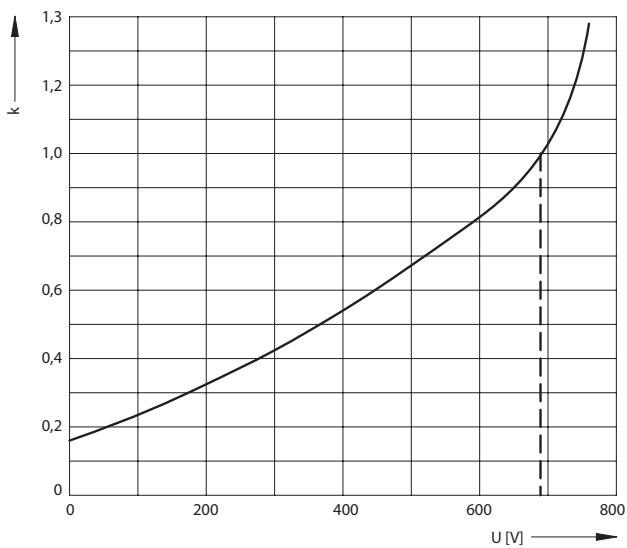

Závislost přepětí na pojistkové vložce pro různá provozní napětí
P50U06, P52U06

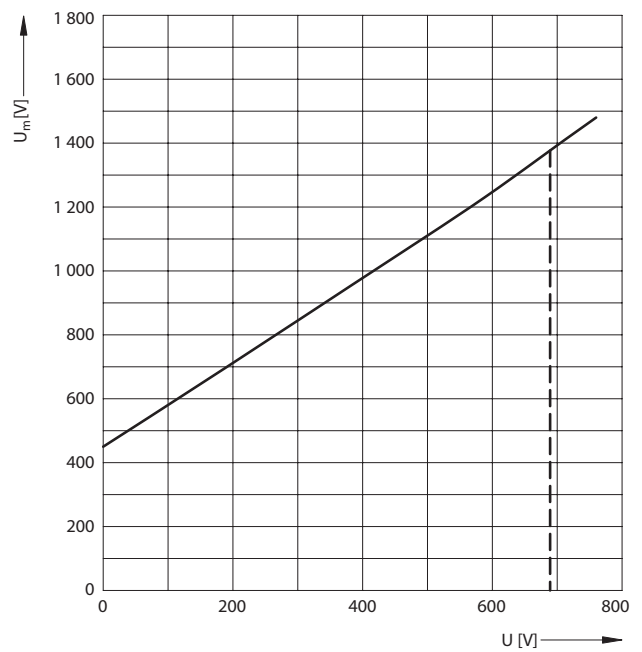

Charakteristiky

Tavná ampérsekundová charakteristika
P40U10 gR, aR

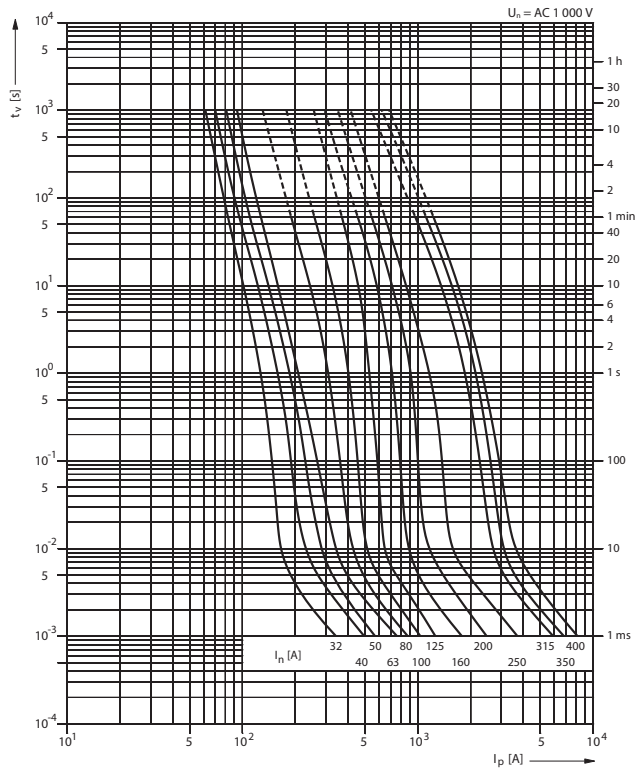

Tavná ampérsekundová charakteristika
P50U10, P50V10 aR

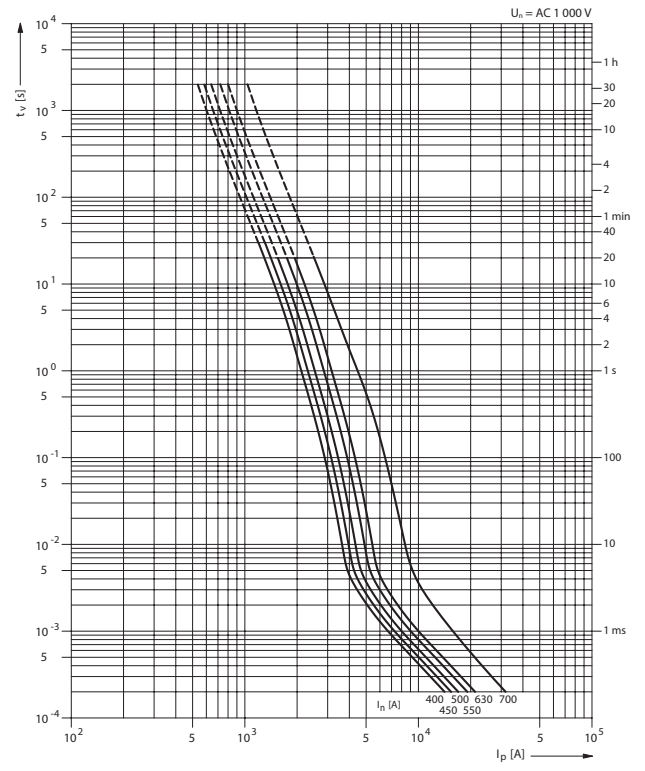

Omezovací charakteristika
P40U10 gR, aR

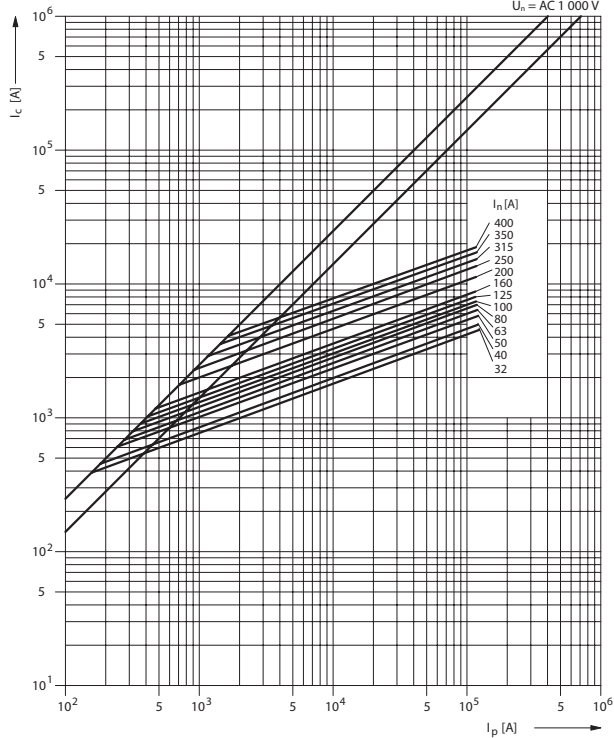

Omezovací charakteristika
P50U10, P50V10 aR

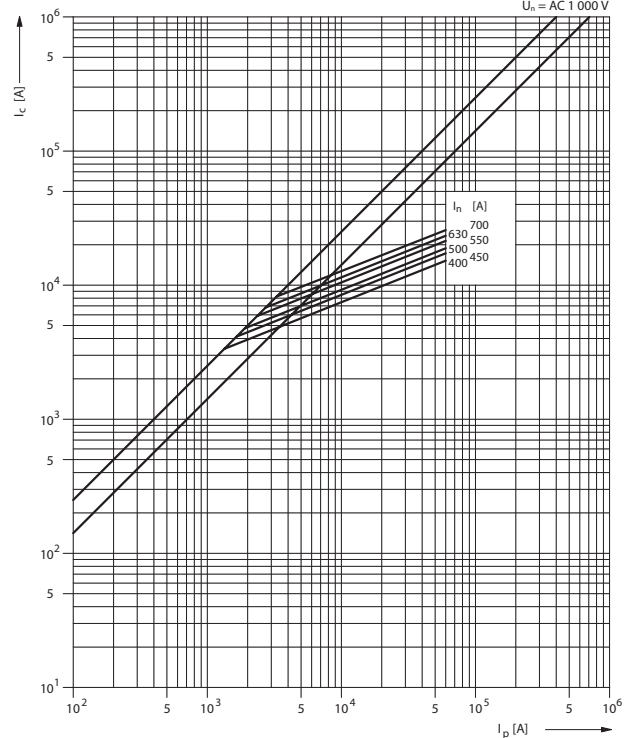

Charakteristiky

Koeficient „k“ závislosti I^2t_c na provozním napětí
 $(I^2t_c)_{f(U)} = k \times I^2t_c$

P40U10, P50U10, P50V10

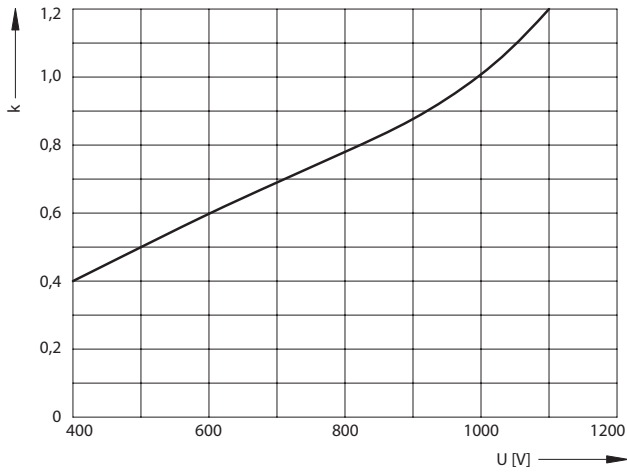

Závislost přepětí na pojistkové vložce pro různá provozní napětí
P40U10, P50U10, P50V10

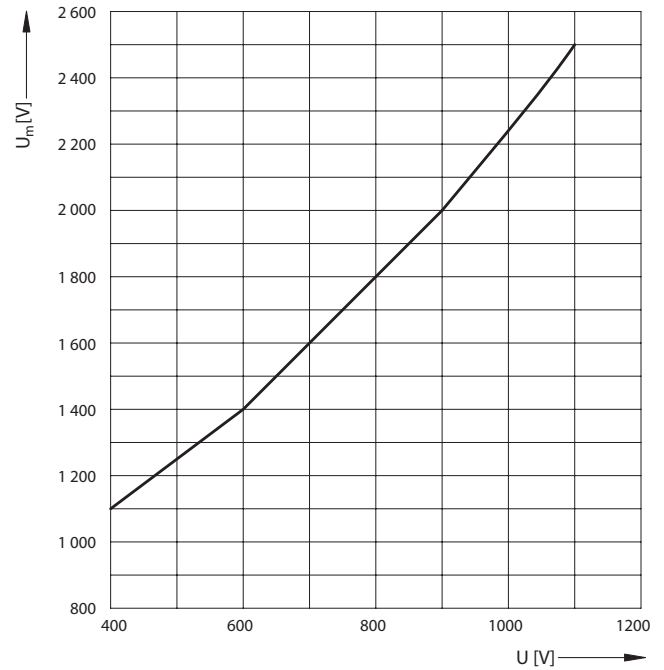

Tavná ampérsekundová charakteristika
P50V16 gR, aR

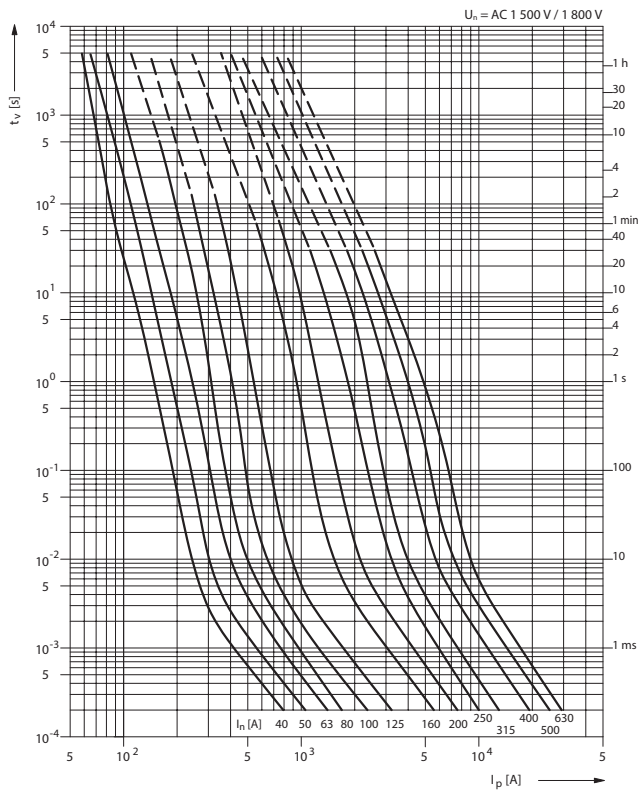

Tavná ampérsekundová charakteristika
P50V16 gR, aR

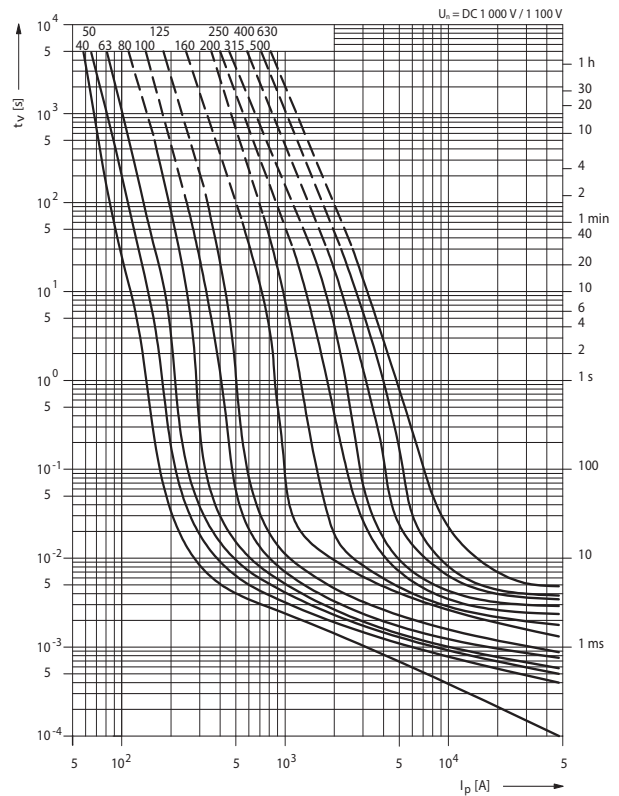

Charakteristiky

Omezovací charakteristika
P50V16 gR, aR

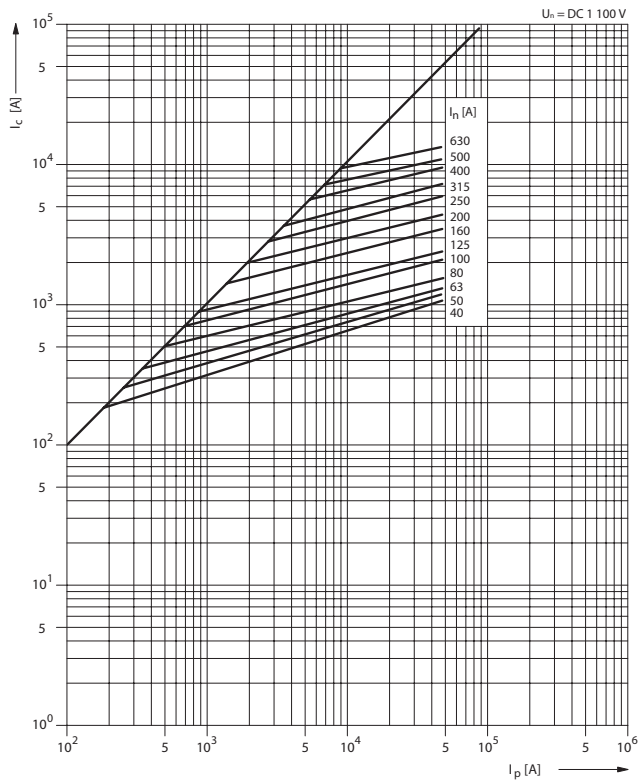

Tavná ampérsekundová charakteristika
P50V30

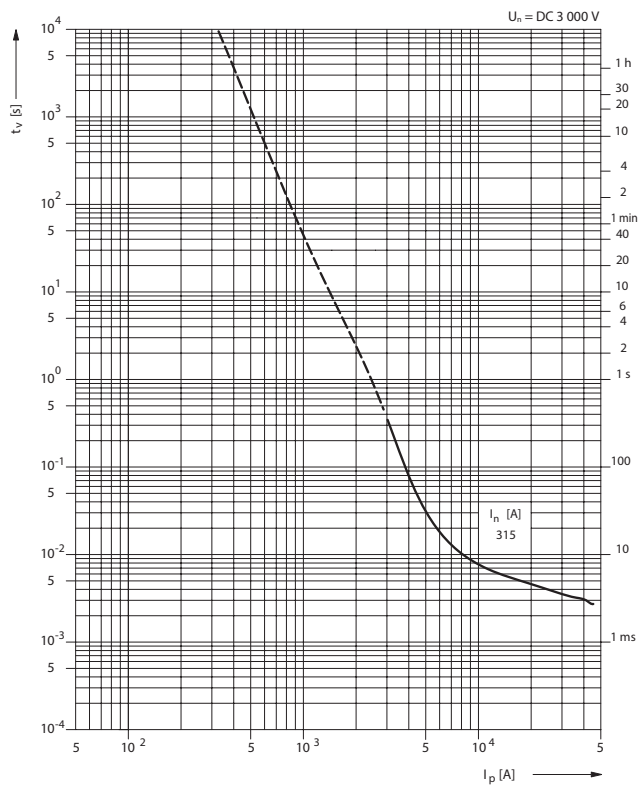

Omezovací charakteristika
P50V30

